

Technical specifications

Panel thickness	min-max 10-45 mm
Edge thickness	min-max 0,4-2,0 mm
Working table dimensions	1800x300 mm
Minimum panel width	110 mm
Minimum panel length (Side being processed)	220 mm
Panel feeder speed	7 mt/l'
Heating elements power Nr. 6	aprox 1,490 kW
Flush trimming motor	0,37 kW
Widia cutterblocks combined	11.000 RPM - Ø 75 mm Z4 - raggio 2 mm/smusso
Total power installed	aprox 2 KW

We reserve the right to make modifications. The illustrated machines may show some units which are not included in the standard version. For photographic reasons some units are without protections. The use of the machine must be made with all protections installed.

Características técnicas

Altura del panel	min-max 10-45 mm
Espesor del canto	min-max 0,4-2,0 mm
Medidas de la mesa de trabajo	1800x300 mm
Anchura mínima panel	110 mm
Longitud mínima panel (lado de chapear)	220 mm
Velocidad de avance del panel	7 mt/l'
Potencia resistencias N° 6	aprox. 1,490 kW
Motor perfilador	0,37 kW
Fresas en Widia combinadas	11.000 RPM - Ø75 mm Z4 - rayon 2 mm/chanfrein
Potencia total instalada	aprox. 2 KW

Nos reservamos el derecho de hacer modificaciones sin previo aviso. La maquina ilustrada puede tener equipos no incluidos en la version estandar. Por razones fotograficas algunos grupos son sin proteccion. El uso de la maquina se entiende con todas las protecciones montadas.

Características técnicas

Altura do painel	min-max 10-45 mm
Espessura do bordo	min-max 0,4-2,0 mm
Dimensões da superfície de trabalho	1800x300 mm
Largura mínima do painel	110 mm
Comprimento mínimo do painel (lado a ser colado)	220 mm
Velocidade do avanço do painel	7 mt/l'
Potência resistências N° 6	aprox. 1,490 kW
Motor refilador	0,37 kW
Fresas em Widia combinadas	11.000 RPM - Ø75 mm Z4 - Radio 2 mm/bisel
Potência total instalada	aprox. 2 KW

Reservamos o direito de fazer modificações sem aviso prévio. A máquina ilustrada pode conter elementos que não estão incluídos na versão padrão. Por razões de fotografia alguns grupos são sem protecção. O uso da máquina faz-se com todas as protecções montadas.

Overall dimensions - Dimensiones - Dimensões

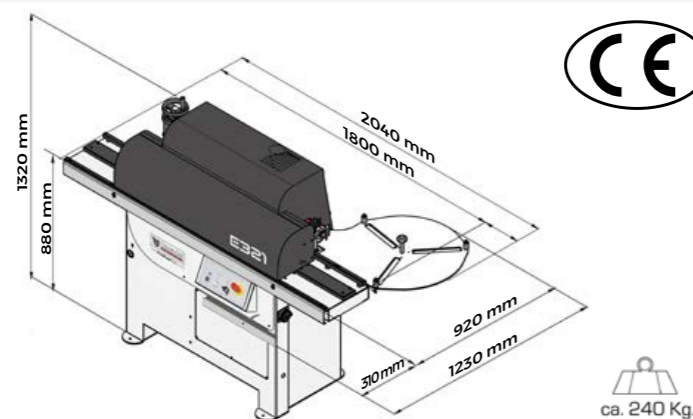

Casadei Industria WOOD S.r.l.
Via Guardia di Rocca, 14
47899 Serravalle
Repubblica di San Marino
Tel. +378 0549 960011
Fax +378 0549 955010
www.casadei-industria.com

E321 03-2021 - ENG - ESP - POR



THINK COMPACT EDGE EASY

ProWoodTech



E321

Automatic edgebander with glue pot
Aplacadora de cantos automática con calderin de cola
Coladeira de bordo automatica com deposito de cola



Site



E321



YouTube

E321

Automatic edgebander with glue pot
Aplacadora de cantos automática con calderin de cola
Coladeira de bordo automática com deposito de cola



ProWoodTech

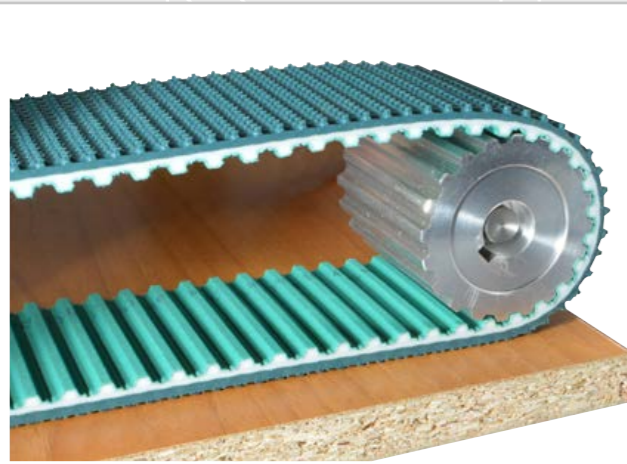

Panel feed unit
Toothed belt
Speed 7 m/min

Conjunto arrastre paneles
Correa dentada
Velocidad 7 m/min

Unidade avanço paineis
Correia dentada
Velocidade 7 m/min

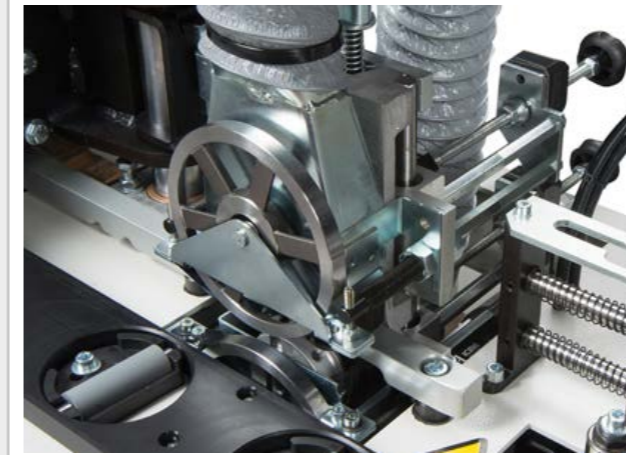
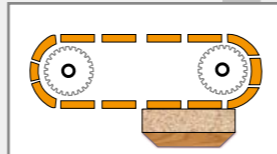

Flush trimming unit with vertical disc copiers as standard

Unidad de perfilado con copidores verticales con rueda como asgo estandar

Refilador com copidores verticais com disco na versão standard

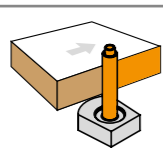
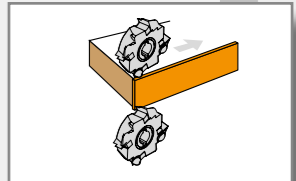

Glue pot
Glue pot capacity 1 Kg.
Teflon coated
Nr. 6 heating elements

Calderin de cola
Capacidad calderin 1 Kg.
Calderin teflonado
Nr. 6 resistencias

Coleiro
Capacidade 1 kg.
Coleiro teflonado
Nr. 6 resistências



Pneumatic edge cutting shears from coil

Cizalla neumática corte bobina

Guilhotina pneumática corte bobina



Pressure bar with handwheel Complete protection guard
Easy access to working units

Prensor con volante Carter de protección integral
Acceso simplificado a los conjuntos

Prensador com volante Carter de protecção integral
Acesso facil aos grupos

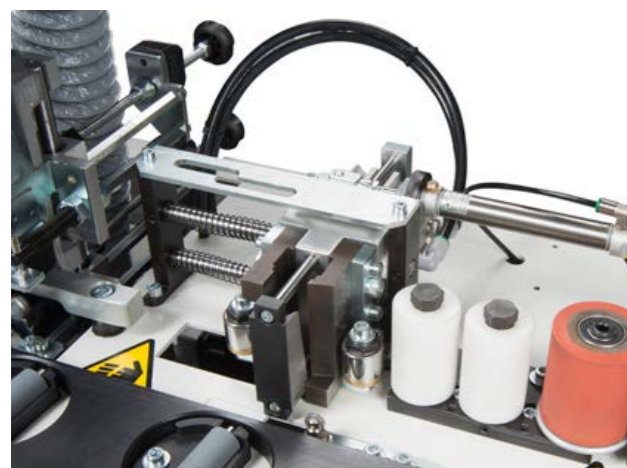
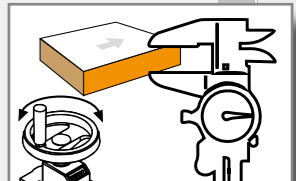

Trimming cut-off
End trims front and rear excess edge
Working cycle controlled by PLC
Exclusion from control panel (PLC)

Retestador del exceso del canto
adelante y detras
Ciclo de trabajo controlado por PLC
Exclusión desde el panel de control (PLC)

Destopador do excesso
da frente e detrás
Ciclo de trabalho controlado por PLC
Exclusão desde o painel de comando (PLC)

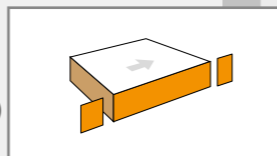

Logic functioning controlled by PLC
Full control of machine
Electronic glue temperature control
Automatic temperature Stand-by
Ergonomic access

Funcionamiento lógico controlado por el PLC
Control completo de la máquina
Control electrónico del calentamiento de la cola
Stand-by automático de la temperatura
Acceso ergonómico

Funcionamento lógico controlado por PLC
Controlo completo da máquina
Controlo electrónico de temperatura da cola
Stand-by automático da temperatura
Acesso ergonómico

THINK COMPACT EDGE EASY

Legislation - Normas - Normas